

LT-858-5A DMX/RDM CV Decoder



LT-858-5A with the standard RDM remote device management protocol, supports DMX512 signal bi-directional communication, achieves remote management of reading and writing DMX address (DMX master controller must recognize the RDM protocol). Realize 0-100% dimming or different lighting effect; workable with single color, bi-color, RGB and RGBW LED lamps.

1. Product Parameter:

LT-858-5A

Input Signal:	DMX512, RDM	Protection:	Short circuit / Over load recover automatically
Input Voltage:	12-24Vdc	Working Temp.:	-30°C~65°C
Output Voltage:	12-24Vdc	Product Size:	L175xW42xH33(mm)
Current Load:	5A×4CH Max. 20A	Package Size:	L183xW48xH41(mm)
Output Power:	[0-60W...120W]×4CH Max. 480W	Weight(G.W.):	310g
DMX512 Socket:	RJ45		

2. Product Size:

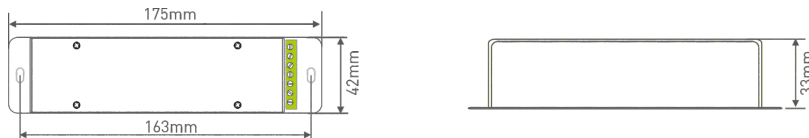

3. Dip Switch Operation:



RDM Mode: The dip switch 1-10 are OFF.

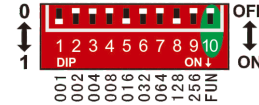

DMX Mode: FUN=OFF (the 10th dip switch=OFF)
Setting DMX addresses with dip switch 1-9

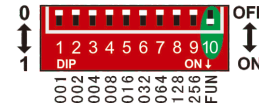

Self-testing Mode: FUN=ON (the 10th dip switch=ON)

3.1 How to set DMX address via dip switch:

FUN=OFF (the 10th dip switch=OFF) DMX Mode

DMX address value = the total value of [1-9], to get the place value when "on" position, otherwise will be 0.

E.g.1: Set Initial Address To 32.

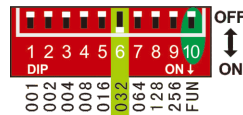

E.g.2: Set Initial Address To 37.



E.g.3: Set Initial Address To 178.

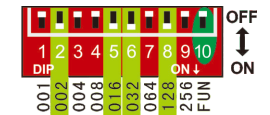

$001+004+032=37$

$002+016+032+128=178$

3.2 Self-testing Mode:

FUN=ON (the 10th dip switch=ON) Self-testing Mode

Dip Switch	1-9=OFF	1=ON	2=ON	3=ON	4=ON	5=ON	6=ON	7=ON	8=ON	9=ON
Self-testing Function	Static Black	Static Red	Static Green	Static Blue	Static Yellow	Static Purple	Static Cyan	Static White	7 Colors Jumping	7 Colors Smooth

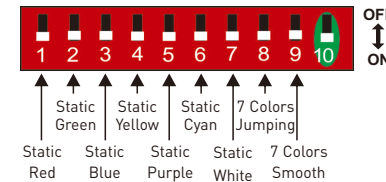

For changing effects (Dip Switch 8/9=ON):
DIP switch 1-7 is used to realize 7 speed levels.
(7=ON, the fastest level)

[Attn] When several dip switches are ON, subjected to the highest switch value.

As the figure above shows, the effect will be 7 colors smooth at 7 speed level.

4. Wiring Diagram:

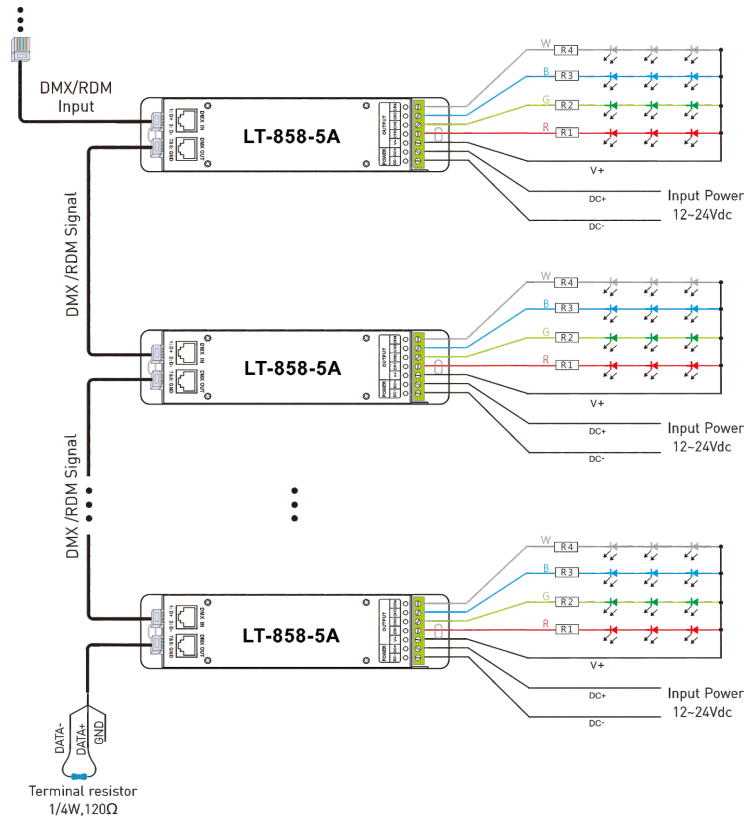
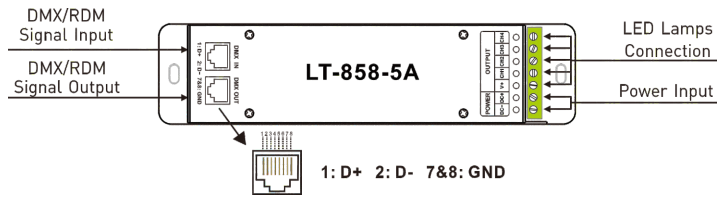

- * If the recoil effect occurs because of longer signal line or bad line quality, please try to connect 0.25W 90-120Ω terminal resistor at the end of each line.
- * An amplifier is needed when more than 32 decoders are connected, signal amplification should not be more than 5 times continuously.

5. Attention:

- 5.1 The product shall be installed and serviced by the qualified person.
- 5.2 This product is non-waterproof, please avoid the sun and rain. When installed outdoors, please ensure it is mounted in a water proof enclosure.
- 5.3 Good heat dissipation will prolong the working life of the controller. Please ensure good ventilation.
- 5.4 Please check if the output voltage of the LED power supply used comply with the working voltage of the product.
- 5.5 Please ensure that adequate sized cable is used from the controller to the LED lights to carry the current. Please also ensure that the cable is secured tightly in the connector.
- 5.6 Ensure all wire connections and polarities are correct before applying power to avoid any damages to the LED lights.
- 5.7 If a fault occurs, please return the product to your supplier. Do not attempt to fix this product by yourself.

6. Warranty Agreement:

- 6.1 We provide lifelong technical assistance with this product:
 - A 5-year warranty is given from the date of purchase. The warranty is for free repair or replacement if cover manufacturing faults only.
 - For faults beyond the 5-year warranty, we reserve the right to charge for time and parts.
- 6.2 Warranty exclusions below:
 - Any man-made damages caused from improper operation, or connecting to excess voltage and overloading.
 - The product appears to have excessive physical damage.
 - Damage due to natural disasters and force majeure.
 - Warranty label, fragile label and unique barcode label have been damaged.
 - The product has been replaced by a brand new product.
- 6.3 Repair or replacement as provided under this warranty is the exclusive remedy to the customer. We shall not be liable for any incidental or consequential damages for breach of any stipulation in this warranty.
- 6.4 Any amendment or adjustment to this warranty must be approved in writing by our company only.

★This manual only applies to this model. We reserve the right to make changes without prior notice.